

OPERATION

This is a direct-acting, 3-way, 2-position, spool-type solenoid valve. Recommend the following connections: port 3 to inlet, port 1 to actuator and port 2 to drain. When de-energized, the SV08-23-02 allows flow from port 1 to port 2, while port 3 is blocked. When energized, flow is allowed from port 2 to port 1, while port 2 is blocked. Follow the "Operating Envelope" limits to ensure shifting of the valve during operation.

APPLICATIONS

Common applications include on-off control of single-acting cylinders, clutches, or motors. Solenoid spool-type valves are direct acting and respond quickly to coil voltage input. Spool valves will have some leakage due to spool clearance, so if your application requires no leakage at the working port(s), apply a low leakage poppet valve(s), like PO check valve, counterbalance valve, etc., in addition to this solenoid valve. This valve can operate with an inlet pressure of 315 bar for 400,000 cycles. In case of inlet from port 2 this value can be increased to 600,000 cycles.

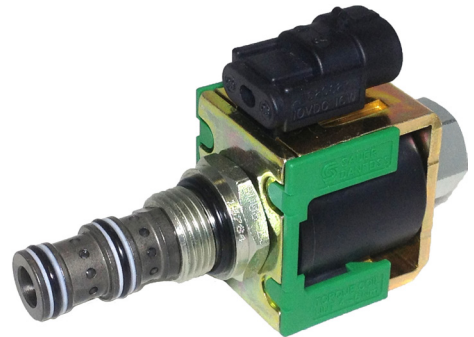

Shown with Robust Coil,
 Metri-Pack Type 2 Connector

SPECIFICATIONS

Rated pressure*	230 bar [3300 psi]**
Rated flow at 7 bar [100 psi]	10 l/min [3 US gal/min]
Weight	0.31 kg [0.68 lb]
Cavity	SDC08-3
Standard Coil	M13 20 Watt
Robust Coil	R13 16 Watt Robust Nut P/N 173800539 (no coil O-rings needed)

* Rated Pressure based on NFPA fatigue test standards (at 1 Million Cycles).
 ** See 315 bar pressure rating note on page 10.

SCHEMATIC

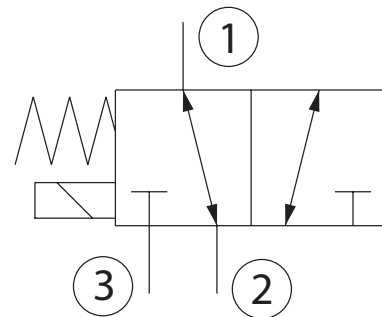

PERFORMANCE CURVES

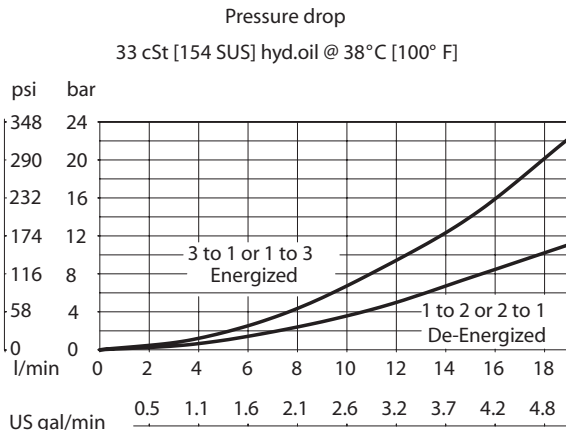

Operating envelope

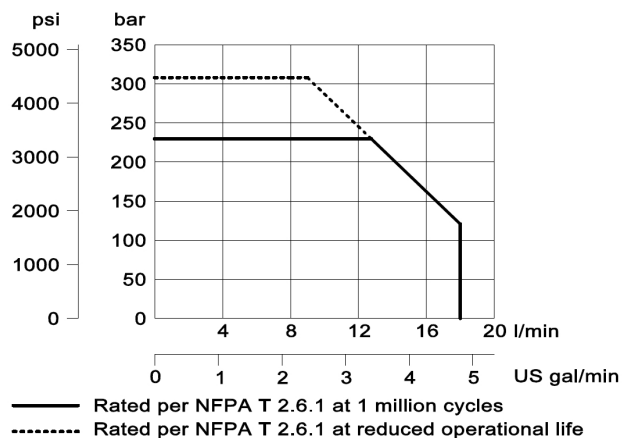

DIMENSIONS

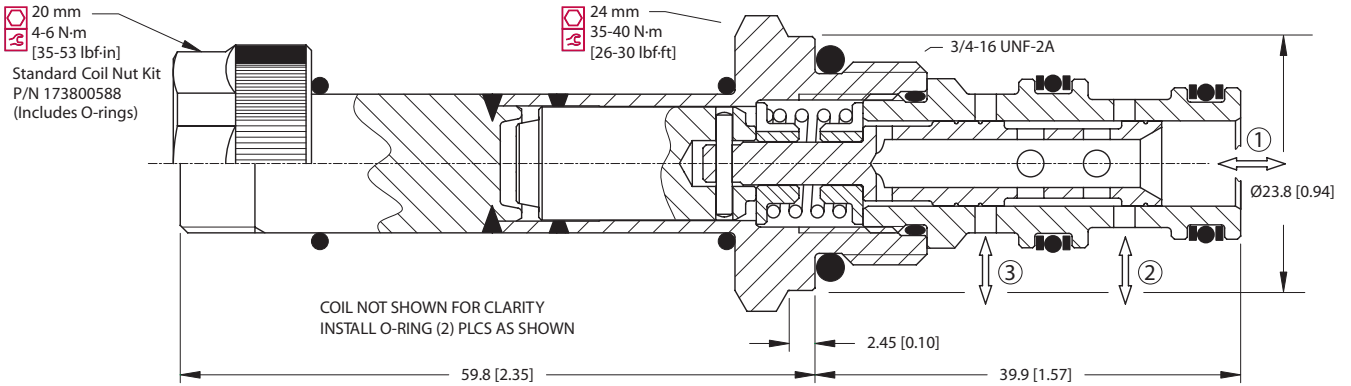

EXAMPLE CIRCUITS

On/Off Pilot Control for Directional Spool Valve

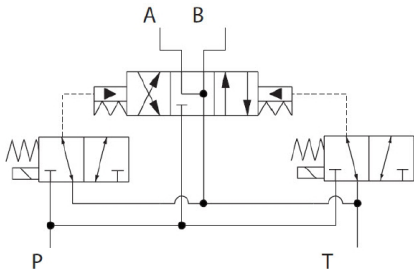

On/Off Pilot Control for Single-Acting Cylinder, Clutch or Brake

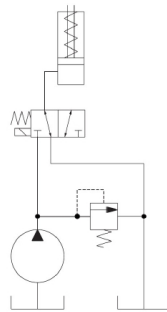

Create a Low Pressure 4-Way, 3-Position Directional Control Valve

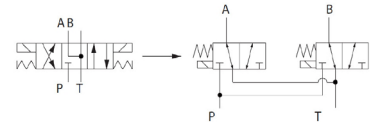

SV - Solenoid Valves
 SV08-23-02

ORDERING INFORMATION

SV08 - 23 - 02 - 12D - DE - B - 00

Solenoid Valve, 08
 Size Cavity

23:
 2 Position, 3 Way, Spool Type

02:
 Schematic: Pull Type

Code	Body and Ports	Body Nomenclature
00	Cartridge Only	No Body
4S	#4 SAE, AL	CP08-3-4S
6S	#6 SAE, AL	CP08-3-6S
S6S	#6 SAE, Steel	CP08-3-S6S
SE2B	1/4 BSP, AL	SDC08-3-SE2B
SE3B	3/8 BSP, AL	SDC08-3-SE3B
S3B	#6 SAE, Steel	CP08-3-S3B

Seal Code	Material	Seal Kits
B	Buna-N	354003210
V	Viton	354003819

Coil Voltage	Standard Coil Code	Robust Coil Code
No Coil, with nut*	00	R00
10 VDC	10D	R10D
12 VDC	12D	R12D
20 VDC	20D	R20D
24 VDC	24D	R24D
110 VAC**	110A	-
220 VAC**	220A	-

* Standard coil – plastic nut and O-rings
 R-coil – steel nut P/N 173800539
 (no coil O-rings needed)
 ** DIN only - external rectifier needed

Coil Termination	Standard Coil Code	IP Rating	Robust Coil Code	IP Rating
No Coil	00	-	00	-
Amp Junior	AJ	IP67	-	-
Amp Junior with Diode	AJD	IP67	-	-
AMP SuperSeal 1.5	AS	IP67	AS	IP69K
AMP SuperSeal with Diode	ASD	IP67	ASDB	IP69K
Deutsch	DE	IP67	DE	IP69K
Deutsch with Diode	DED	IP67	DEDB	IP69K
Flying Leads	FL	IP65	FL	IP69K
Flying Leads with Diode	FLD	IP65	FLDB	IP69K
DIN 43650	DN	IP65	-	-
Metri-Pack 150, Type 2	-	-	M3	IP69K
Metri-Pack 150 with Diode	-	-	M3DB	IP69K