

**OPERATION**

Solenoid Valve, Spool Type, 2-Position, 3-Way, Normally Closed, Pull-Type. Recommend the following connections: port 3 to inlet, port 1 to actuator and port 2 to drain. When de-energized, the HSV10-23-02 allows flow from port 1 to port 2, while port 3 is blocked. When energized, flow is allowed from port 2 to port 1, while port 2 is blocked. Follow the "Operating Envelope" limits to ensure shifting of the valve during operation.



Shown with Robust Coil,  
 Metri-Pack Type 1 Connector

**APPLICATIONS**

Common applications include on-off control of single-acting cylinders, clutches, or motors. Solenoid spool-type valves are direct acting and respond quickly to coil voltage input. Spool valves will have some leakage due to spool clearance, so if your application requires no leakage at the working port(s), apply a low leakage poppet valve(s), like PO check valve, counterbalance valve, etc., in addition to this solenoid valve. In case of inlet from port 2 this value can be increased to 500,000 cycles.

**SPECIFICATIONS**

<b>Rated pressure*</b>	350bar [5075 psi]*
<b>Rated flow at 7 bar [100 psi]</b>	28 l/min [7 US gal/min]
<b>Weight</b>	0.57 kg [1.26 lb]
<b>Cavity</b>	SDC10-3
<b>Standard Coil</b>	H16 29 Watt

\* Rated Pressure based on NFPA fatigue test standards (at 1 Million Cycles).

**SCHEMATIC**

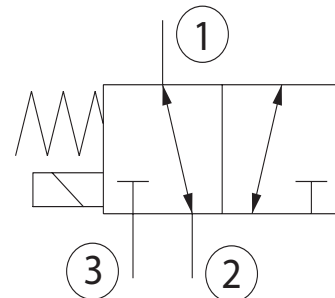

**PERFORMANCE CURVES**

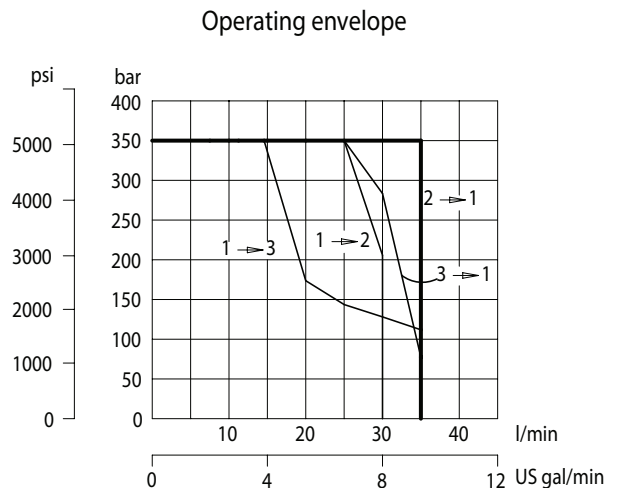
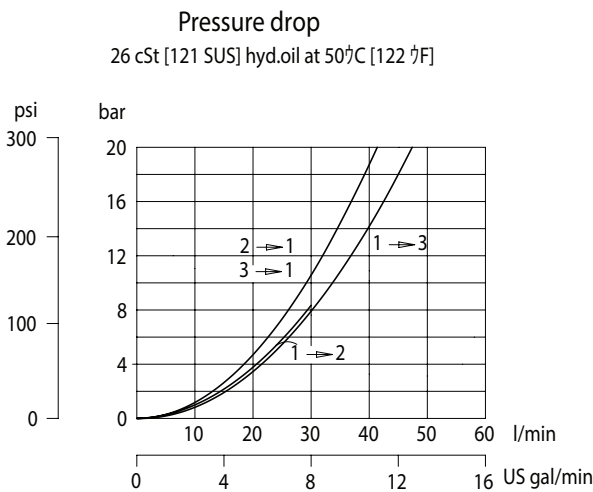

**DIMENSIONS**

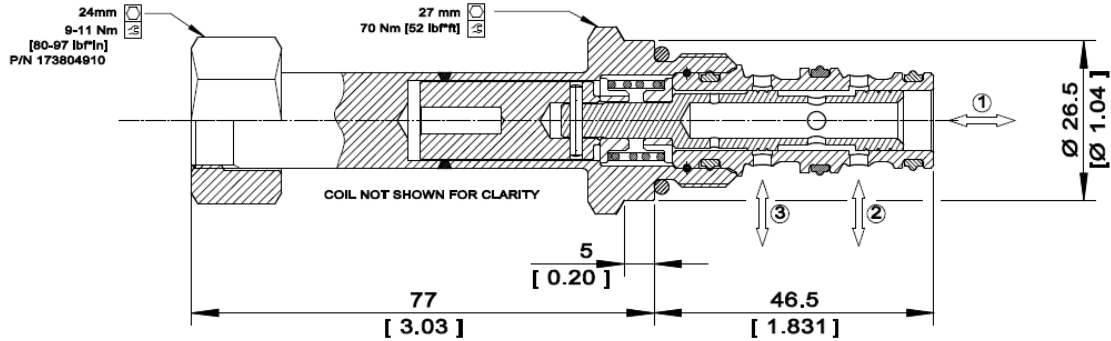

**EXAMPLE CIRCUITS**

*On/Off Pilot Control for Directional Spool Valve*

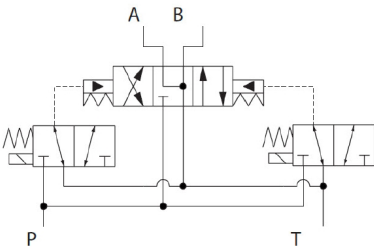

*Create a High Pressure 4-Way, 3-Position Directional Control Valve*

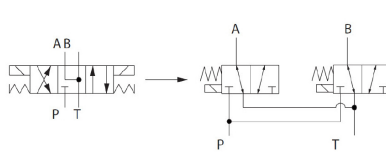

*On/Off Pilot Control for Single-Acting Cylinder, Clutch or Brake*

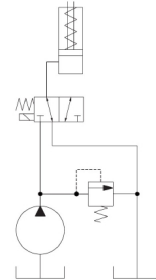

**ORDERING INFORMATION**

**HSV10 - 23 - 02 - H12D - DE - XC - P - 00**

High Pressure Solenoid Valve, This is a direct-acting, 2-position, 3-way, spool-type solenoid valve.

Coil Voltage	
Code	Description
H00	No Coil
H12D	12 VDC
H24D	24 VDC

**Coil Termination**

Code	Description	IP Rating
00	No Coil	-
FL	Flying Lead	IP 69k
DE	Deutsch	IP 69k
AS	AMP SuperSeal 1.5 and Metri-Pack 150 type 1	IP 69k
ASDB	AMP Super Seal with Diode Bidirectional	IP 69k
DEDB	Deutsch with Diode Bidirectional	IP 69k
FLDB	Flying Lead with Diode Bidirectional	IP 69k

**Bodies**

Code	Port & Material	Body Nomenclature
00	Cartridge only	No Body
S3B	3/8 BSP, Ductile	SDC10-3-S3B
S4B	1/2 BSP, Ductile	SDC10-3-S4B
S6S	#8 SAE, Ductile	SDC10-3-S6S
S8S	#8 SAE, Ductile	SDC10-3-S8S

\*\*\* Aluminum bodies available for lower pressure application. Please consult factory for details.

**Seal Option**

Code	Seal Material	Seal kit
P	Polyurethane Single Seal	11140113

**Manual Override**

Code	Description
XC	No Manual Override